

Model 11-2224..... Porter Litter 2 Wheel with 8 Position Handles, Black
Model 11-2224-G..... Porter Litter 2 Wheel with 8 Position Handles, Black- Large "S" Hooks

Disclaimer

This manual contains general instructions for the use, operation and care of this product. The instructions are not all-inclusive. Safe and proper use of this product is solely at the discretion of the user. Safety information is included as a service to the user. All other measures taken by the user should be within and under consideration of applicable regulations. It is recommended that training on the proper use of this product be provided before using this product in an actual situation.

Retain this manual for future reference. Include it with the product in the event of transfer to new users. Additional free copies are available upon request from Customer Care.

Proprietary Notice

The information disclosed in this manual is the property of Traverse Rescue, LLC., Mississauga, ON Canada. Traverse Rescue, LLC. reserves all patent rights, proprietary design rights, manufacturing rights, reproduction use rights, and sales use rights thereto, and to any article disclosed therein except to the extent those rights are expressly granted to others or where not applicable to vendor proprietary parts.

© Copyright Traverse Rescue, LLC. All Rights Reserved

Traverse Rescue, LLC.
2460 Tedlo Street
Mississauga, Ontario
Canada L5A3V3

Telephone:905 279 7866
Toll Free (Canada & US):1 866 998 7866
Fax :905 615-1199

www.traverserescue.com

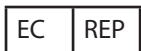

Ferno s.r.l.
Via B.Zallone, 26
40066 Pieve di Cento, Italy
+39 0516860028



Ferno (UK) Limited
Stubs Beck Lane, Cleakheaton
West Yorkshire BD19 4TZ, United Kingdom
44 (0) 1274 851999



Traverse Rescue, LLC manufactures our products under a strict Quality Management System. Traverse Rescue LLC is an ISO 9001:2015 certified company.

The CE and UKCA symbols on Traverse Rescue, LLC products signify this product has been certified in accordance with the European Community Council Directive 93/42/EEC. Traverse Rescue, LLC declares this product meets EC Regulation (EU) 2017/745.

Porter Transport Systems manufactured by Traverse Rescue, LLC have been determined to be Class 1 medical devices.

1. Safety Information

1.1 Warnings

The following are warnings in this manual:



Untrained operators can cause injury or be injured. Permit only trained personnel to operate the Porter.
*

Improper use of the Porter can cause injury. use the Porter only for the purpose described in this manual
*

An unrestrained or improperly restrained patient can suffer injuries. Always secure the patient in the Porter with a restraint system suitable to the situation
*

Improper operation can cause injury. Operate the Porter only as described in this manual
*

An un-attended patient can be injured. Stay with the patient at all times
*

Helpers can cause injury or be injured. Maintain control of the Porter and direct all helpers
*

Improper maintenance can cause injury and damage. Maintain the Porter only as described in this manual
*

Improper parts and service can cause injury. Use only Traverse-approved parts and service on the Porter.
*

Modifying the Porter can cause injury and damage. Use the Porter only as-sold by Traverse.
*

Attaching improper or inappropriate items to the Porter can cause injury. Use only Traverse-Approved items on the Porter.*

1.2 Important

Boxes like the one below emphasize important information.

IMPORTANT

Rescue procedures using ropes, harnesses, bridles and other Personal Protective Equipment require special skills and are potentially hazardous activities. Rescue personnel should not attempt such rescue procedures until they have received professional instruction and training.

1.3 Bloodborne Disease Notice

OSHA (Occupational Safety and Health Administration) requires employers to protect workers from workplace exposure to bloodborne diseases such as HIV-1 and hepatitis. To reduce the risk of exposure when using the rescue litter, follow disinfecting and cleaning instructions in this manual.

1.4 Safety Labels

Labels place important information from the Users' Manual on the Porter.

Read and follow label instructions. Replace worn or damages labels immediately. New labels are available from Traverse.

The Load-Limit label shown is affixed to the rescue litter.



2. Operator Skills and Training

2.1 Skills

Operators using the Porter need:

- A working knowledge of emergency patient-handling procedures.
- The ability to assist the patient.
- A complete understanding of the procedures described in this manual.

2.2 Training

Trainees need to:

- Follow a training program designed or approved by their training officer
- Read this manual. For additional free users' manuals, contact Traverse Customer Care.
- Practice with the rescue litter before using it in regular service
- Be tested on their understanding of the Porter
- Record their training information. A sample Training Schedule and Maintenance Record sheet is provided

3. About the Porter

3.1 Porter Description

The Porter is designed to transport most styles of rescue litter or backboard over rough terrain during emergency rescue operations.

The Porter is for use by trained rescue personnel. A minimum of two personnel are needed to operate the Porter when transporting a patient, but additional help may be required in certain situations and conditions. the Porter features include:

- Design accommodates all Traverse Rescue Litters and most styles of other rescue litters
- Wheels can be removed quickly for storage or transport inside the frame
- Pair of securing straps use ratchet buckles for fast and tight hold, and vinyl-coated hooks
- Optional handles provide enhanced control

3.2 General Specifications

Porter (Deployed)		
Length	33 in	84 cm
Width	26 in	66 cm
Depth	29 in	74 cm
Depth (Stored)	19 in	48 cm
Weight	41 lbs	19 kg
Rated Load Limit	500 lbs	227 kg

Porter With Handles (Deployed)		
Length	96 in	244 cm
Length (Stored)	33 in	84 cm
Width	26 in	66 cm
Width (Stored)	32 in	81 cm
Depth	29 in	74 cm
Depth (Stored)	32 in	81 cm
Weight	51 lbs	23 kg
Rated Load Limit	500 lbs	227 kg

Construction
 Frame Aluminum
 Axle 3/4-in. Stainless Steel
 Tire AT 22x11-8
 Operate at 10 psi maximum

Specifications are rounded to the nearest whole number. Metric conversions are calculated before rounding the Imperial measurements. Traverse reserves the right to change specifications without notice.

!!! WARNING !!!

Untrained operators can cause injury or be injured. Permit only trained personnel to operate the Porter.

3.3 Components

Porter, No Handles



Porter with Handles

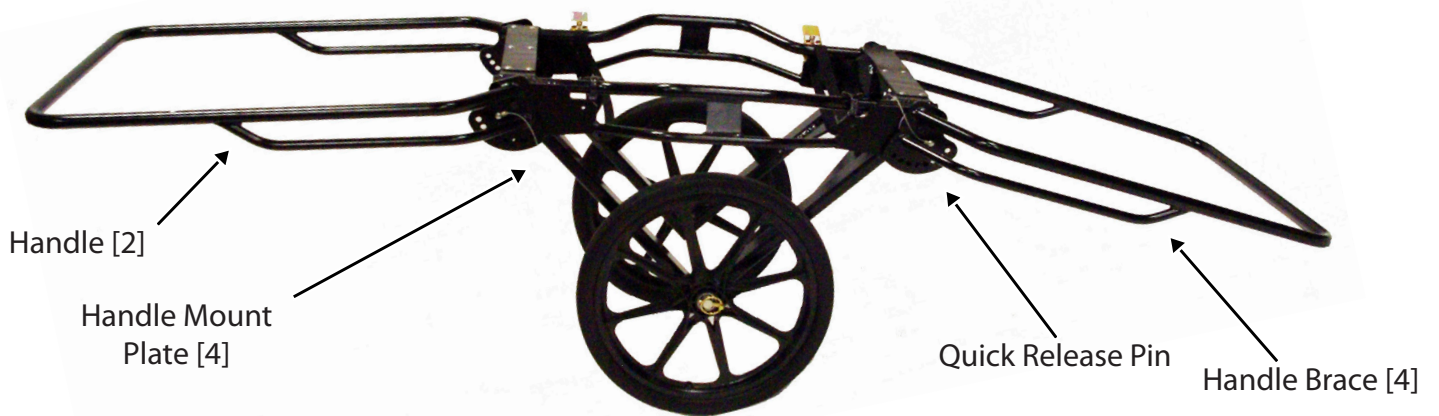

4. Operating the Fasteners

4.1 Ratchet Buckles

The Porter is equipped with two tie-down straps fitted with ratchet buckles (Fig. 1) for securing the rescue litter to the Porter.

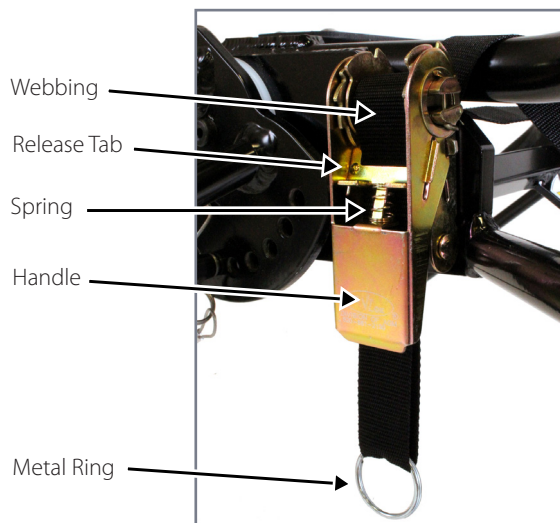

Figure 1. Ratchet Buckle Components

4.2 Releasing Tension on the Strap

1. Depress and hold release tab and fully open handle until it clicks into detent. This overrides the ratcheting function (Fig. 2).



Figure 2. Fully Open Handle

2. Pull strap through roller to take up slack, then depress and hold release tab and close handle to release from detent.

4.3 Tensioning the Strap

Work handle up and down until strap is properly tensioned to secure load, then close handle fully to lock and hold strap (Fig. 3).

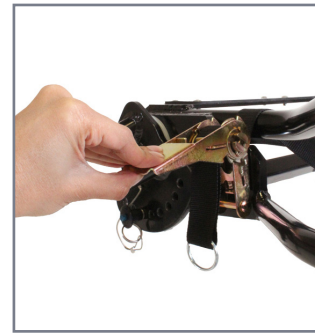

Figure 3. Work Handle Up and Down to Tension

4.4 Lynch Pin for Wheel

The wheel is secured on the axle with a lynch pin. The pin's self-locking ring snaps into place to securely hold the assembly and also allows quick removal. Operate the lynch pin as shown below.

1. Slide lynch pin into axle (Fig. 4).
2. Pivot ring against pin to lock



Figure 4. Lynch Pin in Axle

4.5 Quick Release Pin for Handle Adjustments

The handles (optional feature) adjust to 8 positions. The quick release pin secures the handle in the selected position (Fig 5 and 6).



Figure 5



Figure 6

5. Deployment & Breakdown

5.1 Deployment without Handles

1. Begin with the Porter in storage position and remove the lynch pin from the axle (Fig 7).



Figure 7

2. Slide wheel onto axle (Fig. 8).

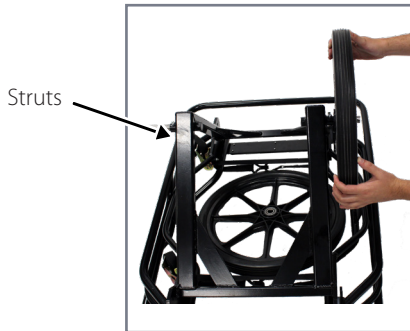

Figure 8. Place Wheel onto Axle

3. Secure wheel on axle with lynch pin (Fig 9).



Figure 9. Lynch Pin in Axle

4. Turn the Porter upright onto its wheel (Fig 10).



Figure 10

5.2 Deployment with Handles

1. Begin with the porter in storage position and remove the lynch pin from the axle (Fig 11).

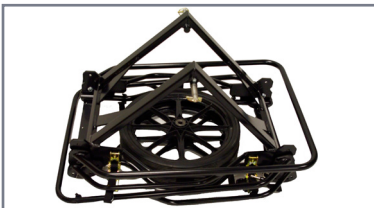

Figure 11

2. Unfold the top handle and lock in place with quick release pins (Fig 12).



Figure 12

3. Slide wheel onto axle (Fig 13).



Figure 13

4. Secure wheel on axle with lynch pin (Fig 14).



Figure 14. Lynch Pin in Axle

5. Turn the Porter upright on its wheel (Fig 15).

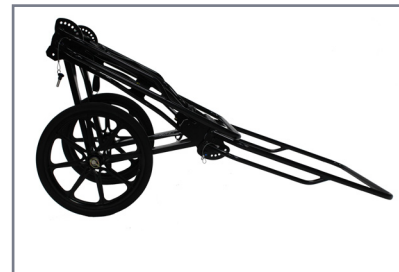

Figure 15

6. Unfold the second handle and lock in position with quick release pins (Fig 16).



Figure 16

5.3 Break Down without Handles

1. Join strap hooks on top of the Porter and tension straps tight against the frame (Fig 17).



Figure 17

2. Turn the Porter upside down (Fig 18).



Figure 18

3. Remove the lynch pin and slide wheel off the axle (Fig 19).



Figure 19

4. Replace lynch pin onto axle and lock (Fig 20).



Figure 20

5.4 Break Down with Handles

1. Join strap hooks on top of the Porter and tension straps tight against the frame (Fig 21).



Figure 21

2. Remove quick release pins from handle and fold handle over top of the Porter (Fig 22).



Figure 22

3. Turn the Porter upside down then remove the lynch pin and slide wheel off the axle (Fig 23).



Figure 23

4. Replace slide lynch pin back into axle and lock (Fig 24).



Figure 24

5. Remove quick release pins from second handle and fold handle over the Porter axle (Fig 25).

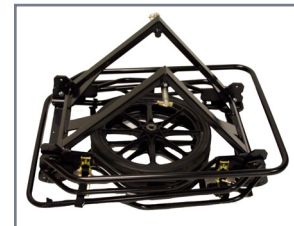

Figure 25

6.0 Attach Rescue Litter to the Porter

Most styles of rescue litters, ski-patrol toboggans, and backboards can be attached to the Porter. Attach the strap hooks to the appropriate rail, handholds, or other element of the rescue litter.

If necessary, the straps can be used full length and wrapped under and over (completely around) the rescue device. Hooks are then joined and straps are tensioned to hold the device tight against the rescue litter supports.

1. Release tension on the straps and separate hooks.
2. Place rescue litter on the Porter and center it over the wheel.
3. Attach all 4 hooks to top rail of rescue litter.
4. Tension both straps until rescue litter is tight against rescue litter supports.
5. Verify that handles on ratchets are closed.

7. Repair, Parts and Service

If the Porter shows excessive wear or cracks (either in the material or at the welds) it is time to retire it from service. Do not attempt to repair or replace any metal component or weld.

If the wheel, straps, labels, or handles are damaged or missing, please call your Dealer or Traverse Rescue Customer Care for replacement parts.

Always follow the instructions packaged with accessories. Keep the instructions with this manual. Be aware of any special considerations (loading heights, door heights, etc.)

Part Number	Description
11-0225	Replacement Wheel
06-0174	Lynch Pin
11-0224	Replacement Handle (each)

8. Limited Warranty

Traverse Rescue, LLC (Traverse) Limited Warranty states that all Traverse products are warranted for a period of one year after the date of invoice, to the original purchaser. This warranty is provided against any material or workmanship flaws or defects. In the event of such a flaw or defect during this warranty period, please contact Traverse Rescue immediately. Traverse Rescue, LLC agrees to repair or replace (at our choice) the defective product. Our Limited Warranty does not cover damage due to abuse, misuse, lack of care, improper use or accidents. It also does not cover damage due to attempted repair by the purchaser that was not authorized by Traverse Rescue, LLC. No other warranties exist or are implied by Traverse Rescue, LLC. This limited warranty excludes, and Traverse shall not be held liable for any punitive, incidental, special or exemplary damages arising out of the breach of the warranty on sales by Traverse or otherwise, or through the performance or non-performance of any third-party part, product, service or system. This limited warranty does not limit in any way, nor alter in any way, other manufacturer's warranties on products that are sold by Traverse Rescue, LLC.

9. Traverse Customer Care

Customer Care and product support are important aspects of each Traverse product.

For assistance with this, or any other Traverse product, please contact Traverse Customer Care.

Please have the serial number of your Traverse rescue litter available when calling Traverse Customer Care, and include this number with any written communications.

Traverse Rescue, LLC.
 2460 Tedlo Street
 Mississauga, Ontario
 Canada L5A 3V3

Telephone905 279 7866
 Toll Free (Canada & US)1 866 998 7866
 Fax905 615 1199
 Email.....info@traverserescue.com
 Websitewww.traverserescue.com



Training Schedule

Date	Name	Training Method

Maintenance Record

Date	Maintenance Performed	By